



■ Features :

- AC input 180~264VAC only
- 130% peak load capability
- 110mm slim design
- Built-in active PFC function compliance to EN61000-3-2
- High efficiency 94% and low power dissipation
- Protections: Short circuit / Overload / Over voltage / Over temperature
- Cooling by free air convection
- Built-in constant current limiting circuit
- Can be installed on DIN rail TS-35/7.5 or 15
- UL508(industrial control equipment)approved
- EN61000-6-2(EN50082-2) industrial immunity level
- Current sharing up to 3840W(3+1)
- Built-in DC OK relay contact
- 100% full load burn-in test
- 3 years warranty



**SPECIFICATION**

MODEL		SDR-960-24	SDR-960-48
OUTPUT	DC VOLTAGE	24V	48V
	RATED CURRENT	40A	20A
	CURRENT RANGE	0 ~ 40A	0 ~ 20A
	RATED POWER	960W	960W
	PEAK CURRENT	52A	26A
	PEAK POWER <small>Note.6</small>	1248W (3sec.)	
	RIPPLE & NOISE (max.) <small>Note.2</small>	180mVp-p	250mVp-p
	VOLTAGE ADJ. RANGE	24 ~ 28V	48 ~ 55V
	VOLTAGE TOLERANCE <small>Note.3</small>	±1.0%	±1.0%
	LINE REGULATION	±0.5%	±0.5%
	LOAD REGULATION	±1.0%	±1.0%
SETUP, RISE TIME	1000ms, 100ms/230VAC at full load		
HOLD UP TIME (Typ.)	14ms / 230VAC at full load		
INPUT	VOLTAGE RANGE <small>Note.7</small>	180 ~ 264VAC    254 ~ 370VDC	
	FREQUENCY RANGE	47 ~ 63Hz	
	POWER FACTOR (Typ.)	PF ≥ 0.95/230VAC at full load	
	EFFICIENCY (Typ.)	94%	94%
	AC CURRENT (Typ.)	6A/230VAC	
	INRUSH CURRENT (Typ.)	COLD START 50A / 230VAC	
LEAKAGE CURRENT	<3.5mA / 240VAC		
PROTECTION	OVERLOAD	Normally works within 105 ~ 130% rated output power for more than 3 seconds and then shut down o/p voltage with auto-recovery after 30 seconds if the peak load condition is removed Constant current limiting within 130 ~ 150% rated output power for more than 3 seconds and then shut down o/p voltage, re-power on to recover	
	OVER VOLTAGE	29 ~ 33V	56 ~ 65V
	OVER TEMPERATURE	90°C ±5°C (TSW) detect on heatsink of power switch Protection type : Shut down o/p voltage, recovers automatically after temperature goes down	
FUNCTION	DC OK RELAY CONTACT RATINGS (max.)	60Vdc/0.3A, 30Vdc/1A, 30Vac/0.5A resistive load	
	CURRENT SHARING	Please refer to function manual	
ENVIRONMENT	WORKING TEMP. <small>Note.5</small>	-30 ~ +70°C (Refer to "Derating Curve")	
	WORKING HUMIDITY	20 ~ 95% RH non-condensing	
	STORAGE TEMP., HUMIDITY	-40 ~ +85°C, 10 ~ 95% RH	
	TEMP. COEFFICIENT	±0.03%/°C (0 ~ 50°C)	
SAFETY & EMC (Note 4)	VIBRATION	Component:10 ~ 500Hz, 2G 10min./cycle, 60min. each along X, Y, Z axes; Mounting: Compliance to IEC60068-2-6	
	SAFETY STANDARDS	UL508, TUV EN60950-1 approved	
	WITHSTAND VOLTAGE	I/P-O/P:3KVAC    I/P-FG:2KVAC    O/P-FG:0.5KVAC    O/P-DC OK:0.5KVAC	
	ISOLATION RESISTANCE	I/P-O/P, I/P-FG, O/P-FG:>100M Ohms / 500VDC / 25°C / 70% RH	
	EMC EMISSION <small>Note.8</small>	Compliance to EN55022 (CISPR22), EN61204-3 Conduction class B, Radiation class A, EN61000-3-2,-3	
OTHERS	EMC IMMUNITY	Compliance to EN61000-4-2,3,4,5,6,8,11, EN55024, EN61000-6-2 (EN50082-2), EN61204-3, heavy industry level, criteria A	
	MTBF	69.8K hrs min.    MIL-HDBK-217F (25°C)	
	DIMENSION	110*125.2*150mm (W*H*D)	
	PACKING	2.47Kg ; 6pcs/15.8Kg/1.55CUFT	
NOTE	<ol style="list-style-type: none"> <li>1. All parameters NOT specially mentioned are measured at 230VAC input, rated load and 25°C of ambient temperature.</li> <li>2. Ripple &amp; noise are measured at 20MHz of bandwidth by using a 12" twisted pair-wire terminated with a 0.1uf &amp; 47uf parallel capacitor.</li> <li>3. Tolerance : includes set up tolerance, line regulation and load regulation.</li> <li>4. The power supply is considered a component which will be installed into a final equipment. The final equipment must be re-confirmed that it still meets EMC directives.</li> <li>5. Installation clearances : 40mm on top, 20mm on the bottom, 5mm on the left and right side are recommended when loaded permanently with full power. In case the adjacent device is a heat source, 15mm clearance is recommended.</li> <li>6. 3 seconds peak power max. and the average output power should not exceed the rate power.</li> <li>7. Derating may be needed under low input voltage. Please check the derating curve for more details.</li> <li>8. Consult MEAN WELL for deployment of Radiation class B.</li> </ol>		

**Mechanical Specification**

Case No.214A Unit:mm

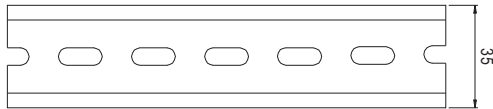
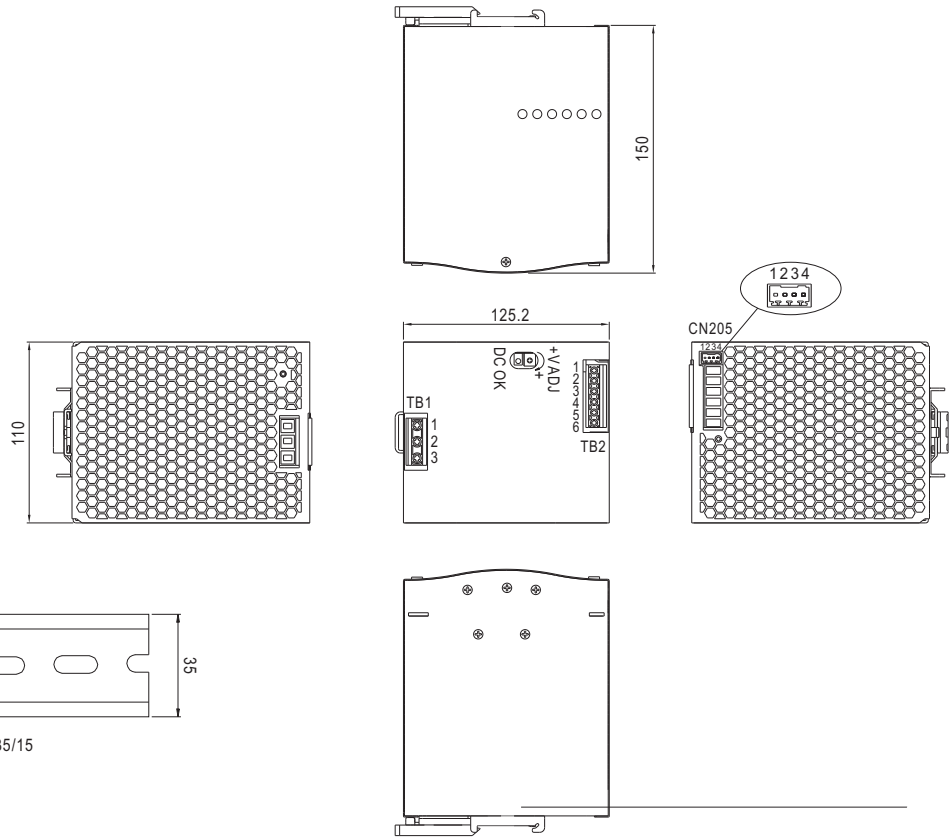

ADMISSIBLE DIN-RAIL: TS35/7.5 OR TS35/15

Terminal Pin No. Assignment (TB1)

Pin No.	Assignment
1	FG Ⓢ
2	AC/N
3	AC/L

Terminal Pin No. Assignment (TB2)

Pin No.	Assignment
1,2,3	DC OUTPUT +V
3,4,6	DC OUTPUT -V

Control Pin (CN205) : DINKLE ECH250R-04P or equivalent

Pin No.	Assignment	Mating Housing	Wire Diameter
1	P-(Current Share)	DINKLE ESC250V-04P or equivalent (including in the single package)	0.081~0.517mm <sup>2</sup> (28~20AWG)
2	P+(Current Share)		
3,4	DC OK Relay Contact		

**Block Diagram**

PFC fosc : 65KHz  
PWM fosc : 60KHz

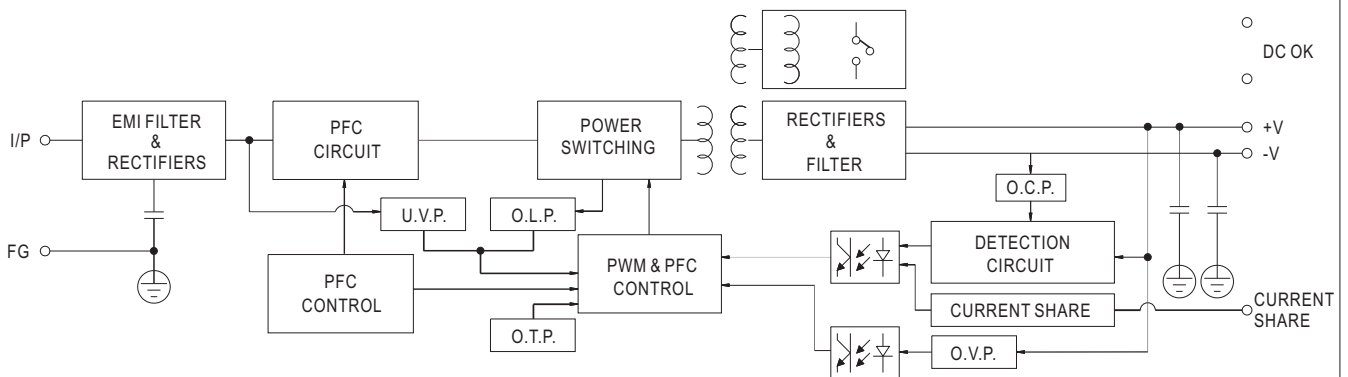

**DC OK Relay Contact**

Contact Close	PSU turns on / DC OK.
Contact Open	PSU turns off / DC Fail.
Contact Ratings (max.)	30V/1A resistive load.

■ Peak Loading

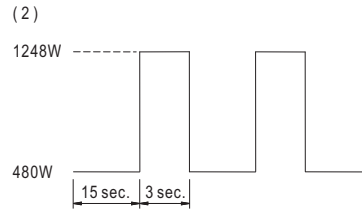
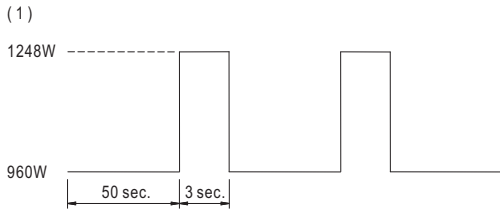

■ Derating Curve

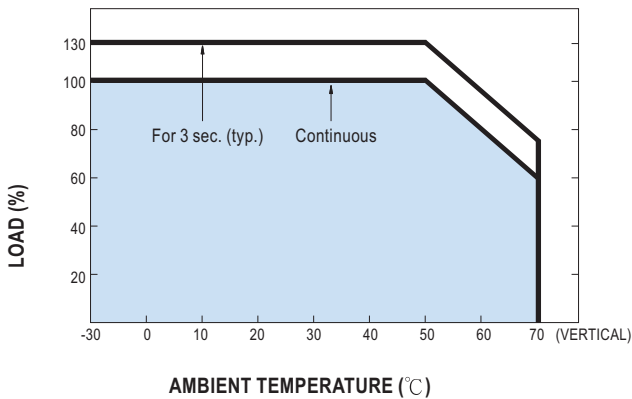

■ Output derating VS input voltage

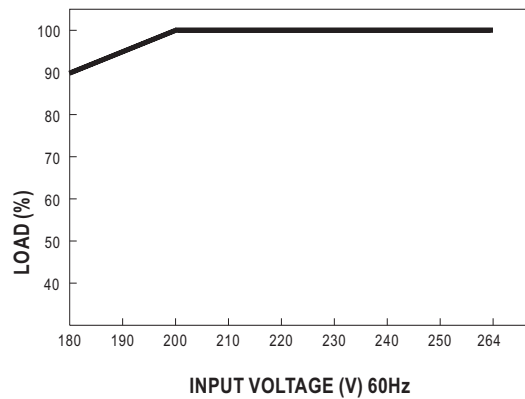

■ Function Manual

1. Current sharing

- (1) Parallel operation is available by connecting the units shown as below (P+,P- are connected mutually in parallel).
- (2) Difference of output voltages among parallel units should be less than 0.2V.
- (3) The total output current must not exceed the value determined by the following equation (Output current at parallel operation)=(The rated current per unit) x (Number of unit) x 0.9.
- (4) In parallel operation 4 units is the maximum, please consult the manufacture for other applications.
- (5) The power supplies should be paralleled using short and large diameter wiring and then connected to the load.
- (6) When in parallel operation, the minimum output load should be greater than 5% of total output load.  
(Min. load >5% rated current per unit x number of unit)
- (7) In parallel connection, maybe only one unit (master) operate if the total output load is less than 5% of rated load condition.  
The other PSUs (slaves) may go into standby mode and their output LEDs & relays will not turn on.
- (8) Some minor noise may be heard at light load condition under parallel operation.  
This is a normal phenomenon and the performance of the PSU will not be influenced.

