

HA6-7.5 (6V-7.5 Ah)

Specifications

Nominal Voltage		6V
Rated capacity (20 hour rate)		7.5 Ah
Dimensions	Length	151±1.5mm(5.94inch)
	Width	34±1mm(1.34inch)
	Height	94±1mm(3.70inch)
	Total Height	100±1mm(3.94inch)
Approx. Weight		1.28kg(2.82lbs)±5%



Outer dimensions (mm)

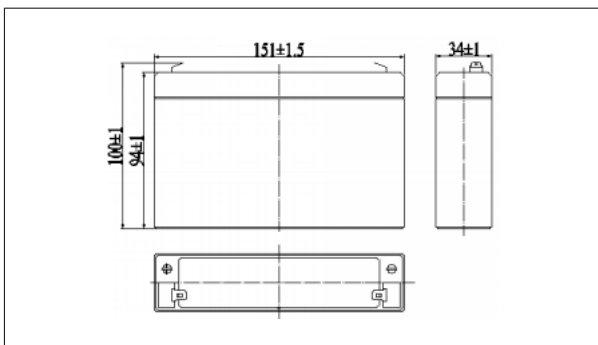

Terminal Type (mm)

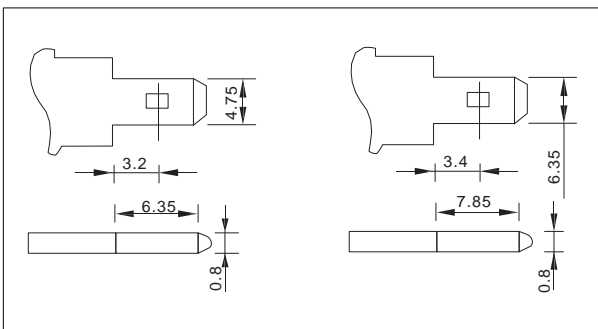

Construction

Component	Positive plate	Negative plate	Container	Cover	Separator	Electrolyte	Safety valve	Terminal
Raw material	Lead dioxide	Lead	ABS	ABS	AGM	Sulfuric acid	Rubber	Copper

Constant Current Discharge Characteristics Unit:A(25°C,77°F)

F.V/Time	5min	10min	15min	30min	60min	2h	3h	4h	5h	10h	20h
4.80V	30.6	19.4	15.1	8.52	5.24	2.87	1.98	1.64	1.40	0.76	0.41
4.95V	29.6	18.8	14.8	8.35	5.16	2.85	1.97	1.63	1.39	0.75	0.40
5.10V	28.4	18.0	14.2	8.09	5.03	2.82	1.96	1.62	1.38	0.75	0.40
5.25V	27.2	17.2	13.7	7.90	4.93	2.78	1.94	1.61	1.37	0.75	0.40
5.40V	25.7	16.3	13.0	7.61	0.78	2.71	1.89	1.56	1.33	0.73	0.39

Constant Power Discharge Characteristics Unit:W(25°C,77°F)

F.V/Time	5min	10min	15min	30min	60min	2h	3h	4h	5h	10h	20h
4.80V	171	109	86.2	48.8	30.3	16.8	11.8	9.77	8.33	4.55	2.44
4.95V	165	106	84.1	47.8	29.9	16.7	11.7	9.71	8.28	4.53	2.43
5.10V	159	102	81.0	46.4	29.1	16.5	11.6	9.64	8.22	4.51	2.41
5.25V	152	97.2	78.3	45.3	28.5	16.3	11.5	9.58	8.17	4.48	2.40
5.40V	143	91.7	74.1	43.6	27.7	15.9	11.2	9.29	7.92	4.39	2.35

Note: The above characteristics data can be obtained within three charge or discharge cycles.

Characteristics

Capacity (25°C)	20HR(5.25V)	7,5Ah
	10HR(5.25V)	6.5Ah
	1HR(4.80V)	4.2Ah
Terminal type		T1/T2
Internal resistance (Fully charged,25°C)		Approx. 10m Ω
Capacity affected by temperature (20HR)	40°C	102%
	25°C	100%
	0°C	85%
	-15°C	65%
Self-discharge (25°C)	3month	Remaining Capacity:91%
	6month	Remaining Capacity:82%
	12month	Remaining Capacity:65%
Nominal operating temperature		25°C ±3°C(77°F ±5°F)
Operating temperature range	Discharge	-15°C~50°C(5°F~122°F)
	Charge	-10°C~50°C(14°F~122°F)
	Storage	-20°C~50°C(-4°F~122°F)
Float charging voltage(25°C)		6.75 to 6.90V Temperature compensation: -9mV/°C
Cyclic charging voltage(25°C)		7.25 to 7.50V Temperature compensation: -15mV/°C
Maximum charging current		2.1A
Maximum discharge current		105A(5 sec.)
Designed floating life(20°C)		5 years

HA6-7.5 (6V-7.5 Ah)

● Discharge characteristics (25°C)

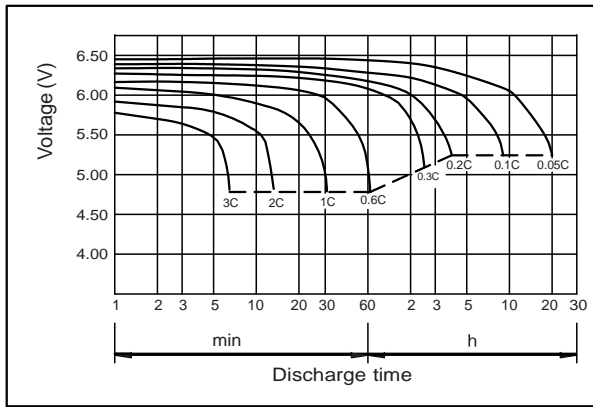

● Charging characteristics (25°C)

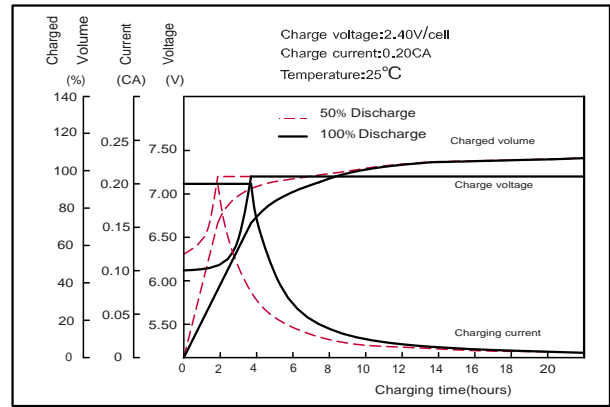

● Effect of temperature on capacity

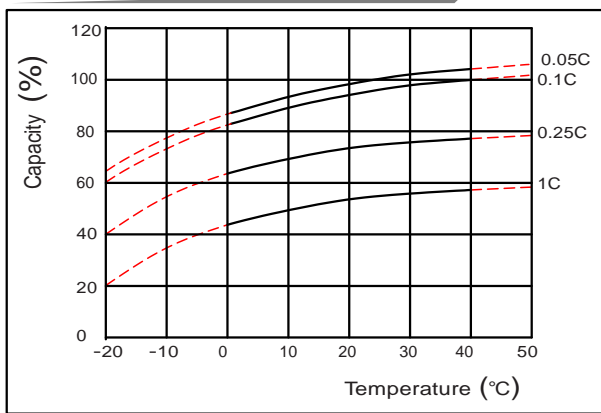

● Self-discharge characteristics

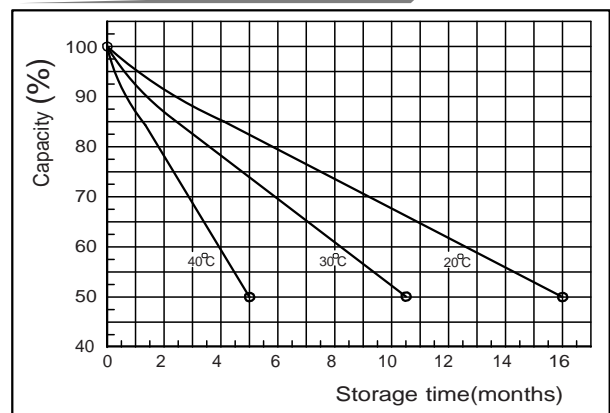

● Floating life on temperature

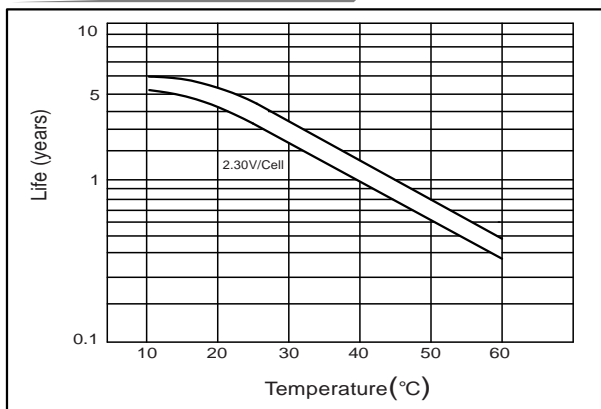

● Cycle life on D.O.D (25°C)

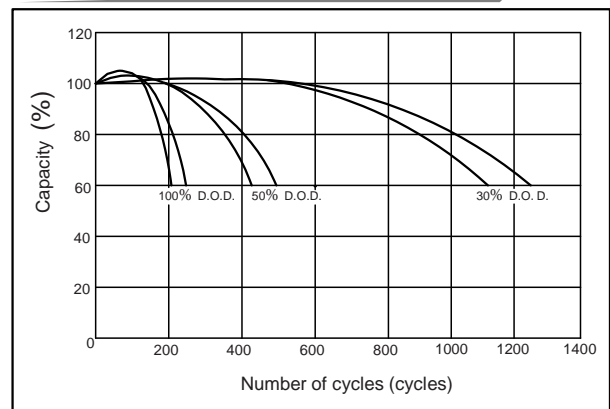

● The relationship for OCV and Capacity (25°C)

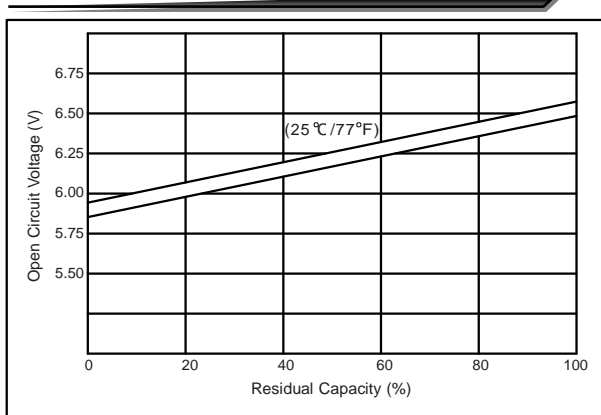

● The relationship for Charging voltage and Temperature

