

HG12-70 12V70Ah

Specifications

Nominal Voltage		12V
Rated capacity (10 hour rate)		70Ah
Dimensions	Length	260±2mm(10.24inch)
	Width	168±2mm(6.61inch)
	Height	211±2mm(8.31inch)
	Total Height	215±2mm(8.46inch)
Approx. Weight		23.2kg(51.1lbs)±3%

Outer dimensions (mm)

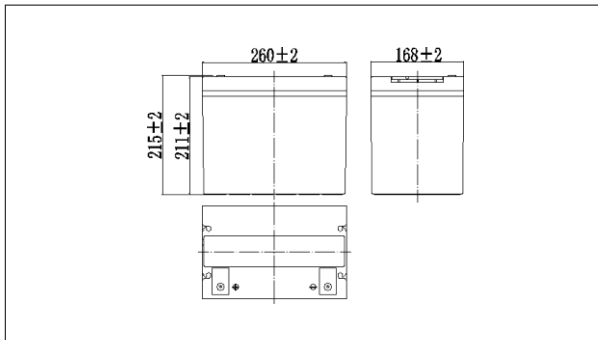

Terminal Type (mm)

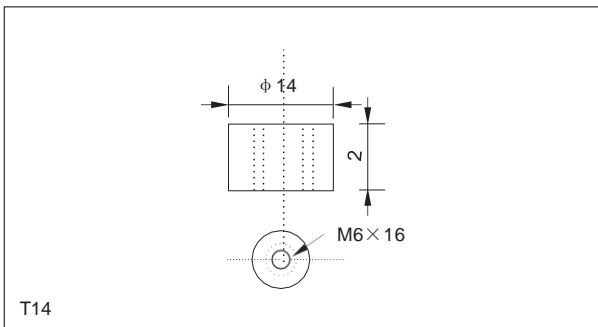

Characteristics

Capacity (25°C)	10HR(10.8V)	70Ah
	3HR(10.8V)	52.5Ah
	1HR(10.5V)	39Ah
Terminal type		T14
Internal resistance (Fully charged,25°C)		Approx.6m Ω
Capacity affected by temperature (10HR)	40°C	102%
	25°C	100%
	0°C	85%
	-15°C	65%
Self-discharge (25°C)	3 months	Remaining Capacity:91%
	6 months	Remaining Capacity:82%
	12 months	Remaining Capacity:65%
Nominal operating temperature		25°C±3°C(77°F±5°F)
Operating temperature range	Discharge	-15°C~50°C(5°F~122°F)
	Charge	-10°C~50°C(14°F~122°F)
	Storage	-20°C~50°C(-4°F~122°F)
Float charging voltage(25°C)	13.50 to 13.80V Temperature compensation: -18mV/°C	
Cyclic charging voltage(25°C)	14.50 to 14.70V Temperature compensation: -30mV/°C	
Maximum charging current	14A	
Maximum discharge current	700A(5 sec.)	
Designed floating life(20°C)	12years	

Construction

Component	Positive plate	Negative plate	Container	Cover	Separator	Electrolyte	Safety valve	Terminal
Raw material	Lead dioxide	Lead	ABS	ABS	AGM	Gel	Rubber	Copper

Constant Current Discharge Characteristics Unit:A(25°C,77°F)

F.V/Time	10min	15min	30min	60min	2h	3h	4h	5h	8h	10h	20h
9.60V	137	112	67.9	42.0	25.6	18.2	14.3	12.1	8.57	7.13	3.78
9.90V	132	109	66.5	41.4	25.4	18.1	14.2	12.1	8.52	7.11	3.77
10.2V	127	105	64.5	40.3	25.2	18.0	14.1	12.0	8.46	7.09	3.76
10.5V	121	102	62.9	39.1	24.8	17.9	14.0	11.9	8.40	7.05	3.74
10.8V	115	96.3	60.6	37.8	24.2	17.5	13.6	11.5	8.15	7.00	3.71

Constant Power Discharge Characteristics Unit:W(25°C,77°F)

F.V/Time	10min	15min	30min	60min	2h	3h	4h	5h	8h	10h	20h
9.60V	1474	1230	762	479	296	214	168	143	102	85.1	45.3
9.90V	1430	1200	747	472	294	213	167	143	101	84.9	45.2
10.2V	1371	1156	724	460	292	211	166	142	100	84.7	45.1
10.5V	1312	1177	706	445	287	210	165	141	99.8	84.2	44.8
10.8V	1238	1058	680	431	280	206	160	136	96.8	83.6	44.5

Note: The above characteristics data can be obtained within three charge or discharge cycles.

HG12-70 12V70Ah

Discharge characteristics(25°C)

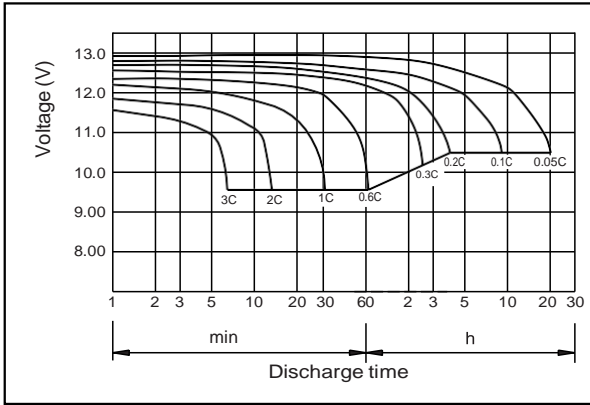

Charging characteristics (25°C)

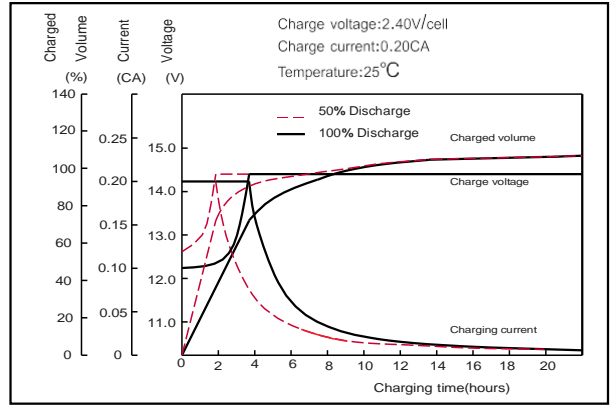

Temperature effects on Capacity

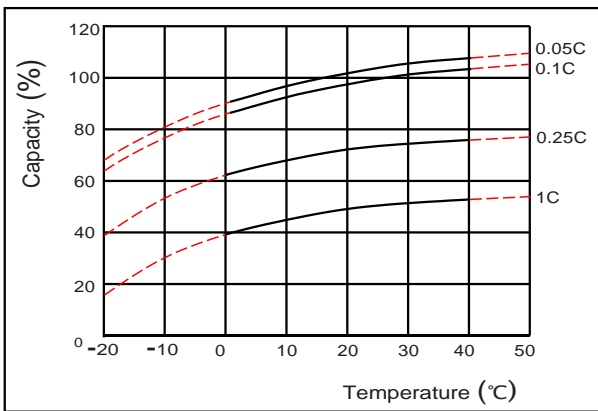

Self-discharge characteristics

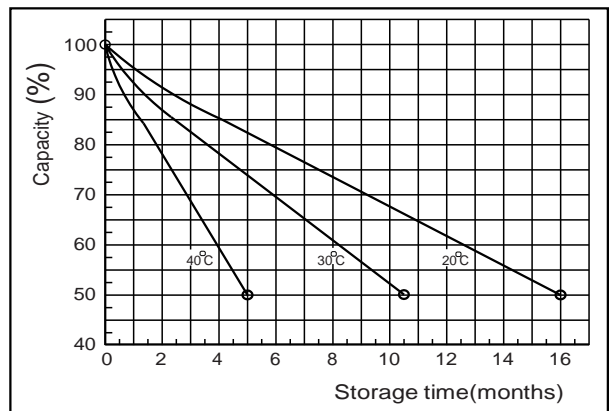

Floating life on Temperature

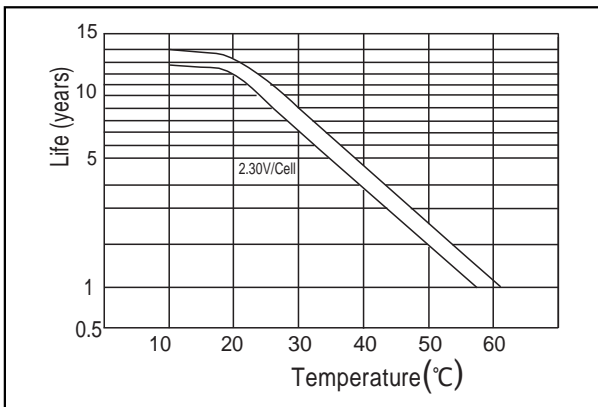

Cycle life on D.O.D (25°C)

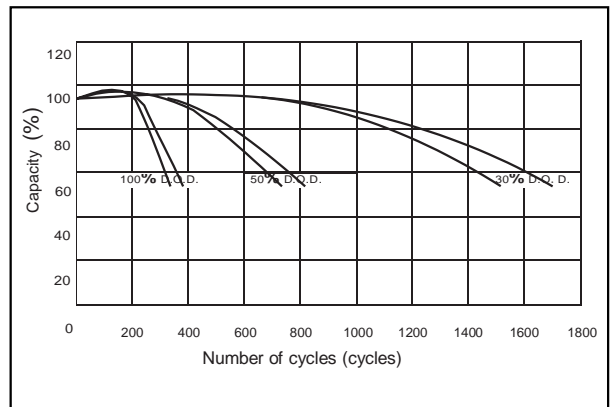

The relationship for OCV and Capacity (25°C)

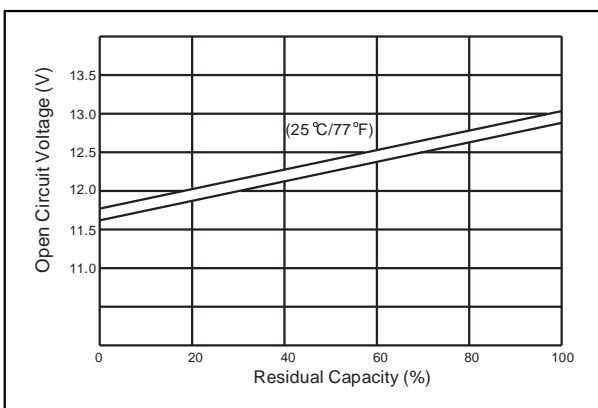

The relationship for Charging voltage and Temperature

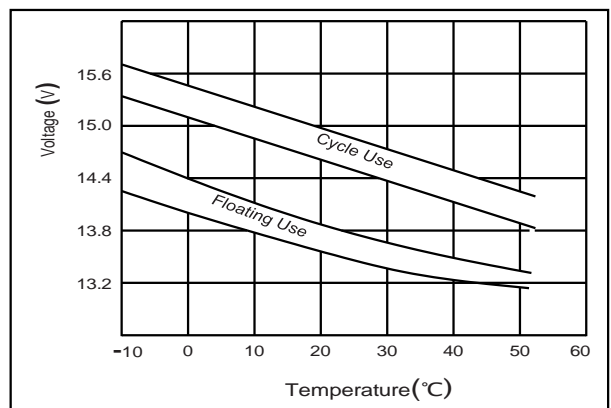

MH47211