

KBAS121800 12V 180Ah

The Kaise Solar Range is mainly used in renewable energy applications, due to its optimal cyclic use performance. It is specially designed for frequent cyclic charge and discharging, providing superior high integrity and reliability. By using strong grids, thick plate and specially active material are designed for repeated deep-discharge applications. Kaise Solar Range offer approx. 30% more cyclic life than the Standard Series.



Performance Characteristics

Nominal Voltage	12V	
Dimensions	Length (mm / inch)	483±2 / 19.0
	Width (mm / inch)	170±2 / 6.69
	Height (mm / inch)	241±2 / 9.49
	Total Height (mm / inch)	241±2 / 9.49
Approx. Weight	(Kg / lbs) 44.0 / 97.0	
Design Life	12 years (floating charge)	
Terminal	M8	
Container Material	A.B.S. UL94-HB, UL94-V0 Optional.	
Rated Capacity	174.8 Ah / 1.748 A	100hr. 1.60V/c. 25°C / 77°F)
	144.3 Ah / 14.43 A	(10hr. 1.75V/c. 25°C / 77°F)
	88.00 Ah / 88.00 A	(1hr. 1.65V/c. 25°C / 77°F)
Max. Discharge Current	1500A (5s)	
Internal Resistance	Approx 5.0mΩ	
Operating Temp. Range	Discharge : -20 ~ 60°C	
	Charge : 0 ~ 50°C	
	Storage : -20 ~ 60°C	
Nominal Operating Temp. Range	25°C ± 5°C	
Cycle Use	Voltage: 14.6V ~ 14.8V at 25°C (77°F)	
	Temp. Compensation: -4mV/°C / Cell	
Float Voltage Use	Voltage: 13.6V ~ 13.8V at 25°C (77°F)	
	Temp. Compensation: -3mV/°C / Cell	
Capacity affected by Temperature	40°C (104°F)	103%
	25°C (77°F)	100%
	0°C (32°F)	86%
Self Discharge	Fully charged Kaise Solar Series batteries may be stored for up to 6 months at 25°C (77°F) and then a freshening charge is required. For higher temperatures the time interval will be shorter.	

Constant Current Discharge (Amperes) at 25°C (77°F)

Volts/cell	1h	3h	4h	8h	10h	24h	100h
1.80V	78.83	37.50	29.61	17.09	14.29	6.280	1.664
1.75V	82.50	38.22	30.32	17.37	14.43	6.343	1.681
1.70V	85.18	39.23	31.17	17.66	14.57	6.405	1.698
1.65V	88.00	40.96	32.16	17.94	14.86	6.531	1.731
1.60V	91.10	42.26	33.15	18.09	15.00	6.594	1.748



Dimensions and Terminal (Unit: mm (inches))

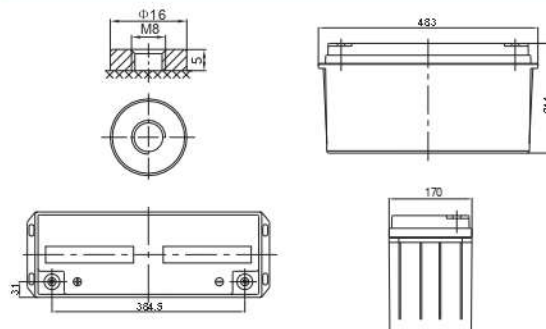

Applications

- Renewable Energy
- Pump Systems
- Traffic lights
- Street Lightening
- Marine equipment
- Caravans & Boats
- Weekend cottage camping
- Telecommunications systems

Certifications

ISO 9001:2008 ISO 14001:2008



Discharge Current vs. Discharge Voltage

Final discharge voltage VCELL	1.8	1.75	1.7	1.6
Discharge current (A)	I ≤ 0.1CA	0.25CA ≥ I > 0.1CA	0.55CA ≥ I > 0.25CA	I > 0.55CA

Constant Power Discharge (Watts per cell) at 25°C (77°F)

Volts/cell	1h	3h	4h	8h	10h	24h	100h
1.80V	152.17	72.98	57.80	33.41	28.00	12.31	3.262
1.75V	158.65	73.39	58.93	33.98	28.29	12.43	3.295
1.70V	163.17	75.25	60.35	34.54	28.57	12.56	3.328
1.65V	168.10	78.25	62.33	34.97	29.13	12.81	3.394
1.60V	171.03	80.25	63.89	35.25	29.42	12.93	3.427

(Note) The above characteristics data are average values obtained within three charge/discharge cycles not the minimum values.

KBAS121800 12V 180Ah



Discharge Characteristics Curve

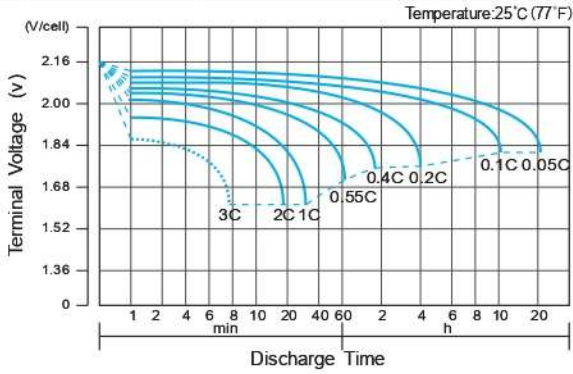

Charge Characteristic Curve for Cycle Use (IU)

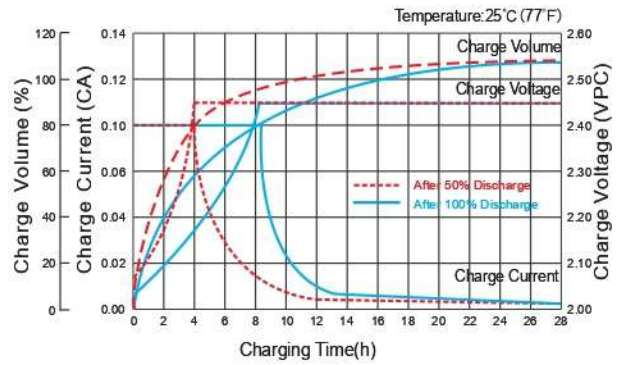

Cycle Life in Relation to Depth of Discharge

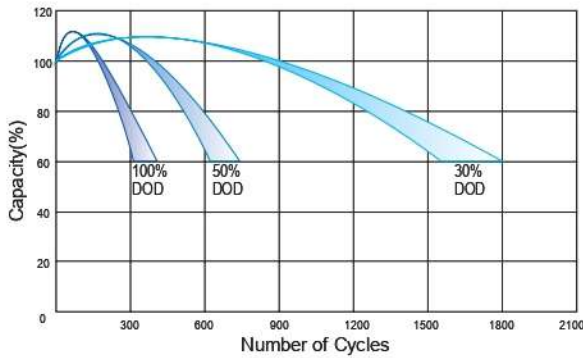

Relation between Charging Voltage and Temperature

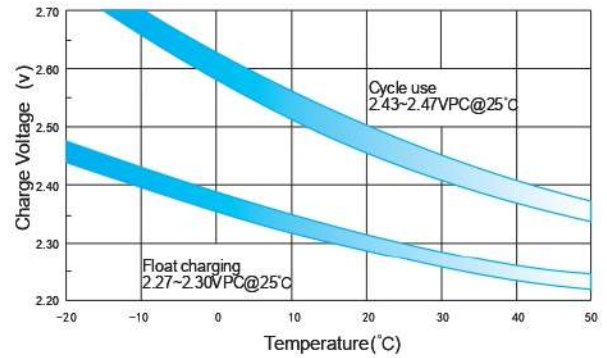

Temperature Effects on Capacity

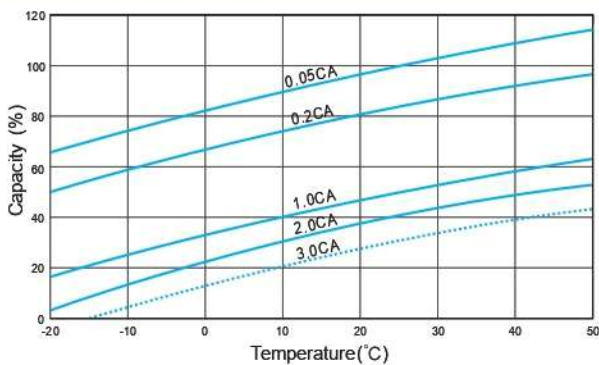

Storage Characteristics

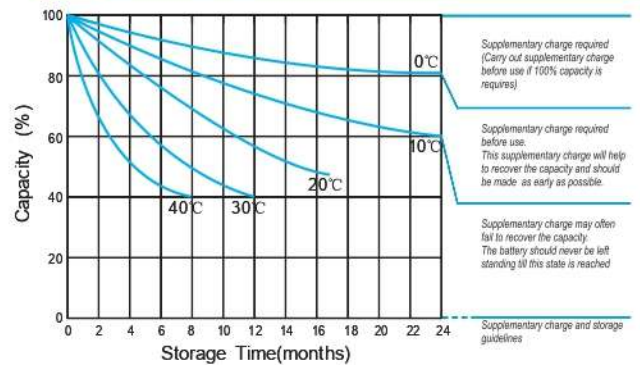

Effect of Temperature on Long Term Life

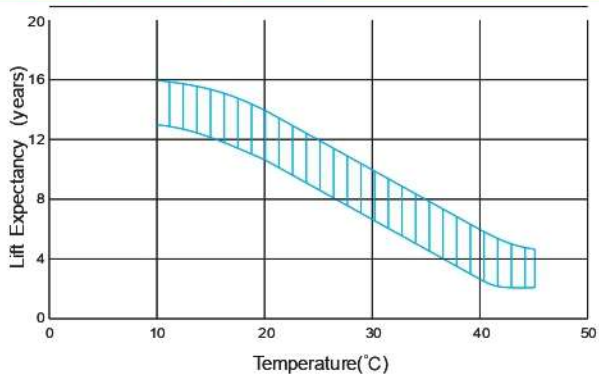

Relation between OCV and State of Charge (20°C)

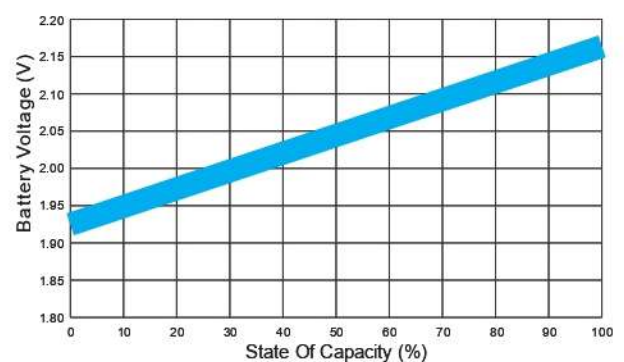

IMPORTANT NOTE: The specifications presented herein are subject to revision without notice.