

### Specification

Nominal Voltage	6V	
Nominal Capacity(20HR)	4.5AH	
Dimension	Length	70±1mm (2.76 inches)
	Width	47±1mm (1.85 inches)
	Container Height	100±2mm (3.94 inches)
	Total Height (with Terminal)	106±2mm (4.17 inches)
	Approx Weight	Approx 0.81 kg (1.79lbs)
Terminal	T1	
Container Material	ABS	
Rated Capacity	4.50 AH/0.225A	(20hr, 1.80V/cell, 25°C/77°F)
	4.19 AH/0.419A	(10hr, 1.80V/cell, 25°C/77°F)
	3.85 AH/0.77A	(5hr, 1.75V/cell, 25°C/77°F)
	3.45 AH/1.15A	(3hr, 1.75V/cell, 25°C/77°F)
	2.83 AH/2.83A	(1hr, 1.60V/cell, 25°C/77°F)
	Max. Discharge Current	67.5A (5s)
Internal Resistance	Approx 25mΩ	
Operating Temp. Range	Discharge	-15~50°C (5~122°F)
	Charge	0~40°C (32~104°F)
	Storage	-15~40°C (5~104°F)
Nominal Operating Temp. Range	25±3°C (77±5°F)	
Cycle Use	Initial Charging Current less than 1.35A. Voltage	
	7.2V~7.5V at 25°C(77°F)Temp. Coefficient -15mV/°C	
Standby Use	No limit on Initial Charging Current Voltage	
	6.75V~6.9V at 25°C(77°F)Temp. Coefficient -10mV/°C	
Capacity affected by Temperature	40°C (104°F)	103%
	25°C (77°F)	100%
	0°C (32°F)	86%
Self Discharge	Leoch LP series batteries may be stored for up to 6 months at 25°C(77°F) and then a freshening charge is required. For higher temperatures the time interval will be shorter.	



### Applications

- ◆ All purpose
- ◆ Uninterruptable Power Supply (UPS)
- ◆ Electric Power System (EPS)
- ◆ Emergency backup power supply
- ◆ Emergency light
- ◆ Railway signal
- ◆ Aircraft signal
- ◆ Alarm and security system
- ◆ Electronic apparatus and equipment
- ◆ Communication power supply
- ◆ DC power supply
- ◆ Auto control system



### Constant Current Discharge (Amperes) at 25 °C (77°F)

F.V/Time	5min	10min	15min	20min	30min	45min	1h	2h	3h	4h	5h	6h	8h	10h	20h
1.85V/cell	8.57	6.58	5.45	4.71	3.64	2.68	2.26	1.34	1.05	0.85	0.69	0.60	0.486	0.406	0.223
1.80V/cell	11.5	8.41	6.59	5.57	4.30	3.12	2.53	1.46	1.13	0.91	0.75	0.65	0.515	0.419	0.225
1.75V/cell	13.0	9.24	7.19	5.99	4.46	3.24	2.65	1.51	1.15	0.93	0.77	0.66	0.524	0.430	0.227
1.70V/cell	14.3	10.1	7.68	6.30	4.65	3.37	2.74	1.55	1.18	0.95	0.78	0.68	0.532	0.438	0.231
1.65V/cell	15.7	10.9	8.17	6.69	4.90	3.45	2.80	1.58	1.23	0.99	0.81	0.69	0.540	0.447	0.234
1.60V/cell	17.4	11.8	8.73	7.13	5.18	3.60	2.83	1.64	1.27	1.02	0.83	0.71	0.545	0.452	0.236

### Constant Power Discharge (Watts) at 25 °C (77°F)

F.V/Time	5min	10min	15min	20min	30min	45min	1h	2h	3h	4h	5h	6h	8h	10h	20h
1.85V/cell	15.7	12.2	10.2	8.88	6.95	5.16	4.37	2.60	2.04	1.66	1.36	1.18	0.959	0.803	0.441
1.80V/cell	20.8	15.4	12.1	10.3	8.07	5.96	4.86	2.82	2.18	1.77	1.45	1.27	1.014	0.827	0.445
1.75V/cell	23.0	16.6	13.1	11.0	8.31	6.12	5.06	2.91	2.22	1.80	1.49	1.30	1.030	0.848	0.449
1.70V/cell	24.6	17.7	13.8	11.5	8.60	6.34	5.21	2.98	2.27	1.85	1.52	1.32	1.043	0.864	0.457
1.65V/cell	26.7	18.9	14.5	12.1	9.00	6.44	5.29	3.00	2.36	1.90	1.56	1.35	1.057	0.881	0.462
1.60V/cell	28.8	20.1	15.3	12.8	9.43	6.68	5.31	3.12	2.42	1.96	1.61	1.37	1.065	0.889	0.464

## Dimensions

### T1 Terminal Unit: mm [inches]

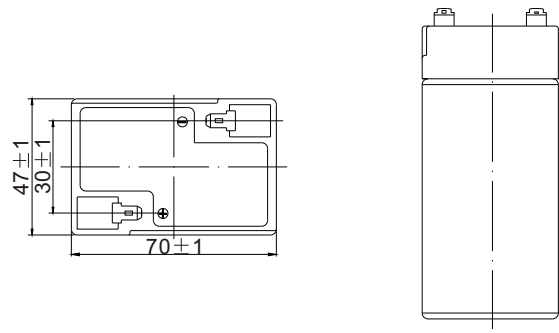
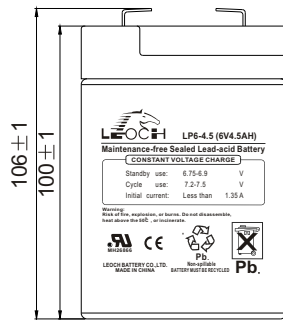
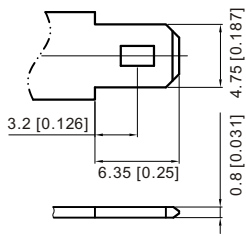

## Discharge Characteristics

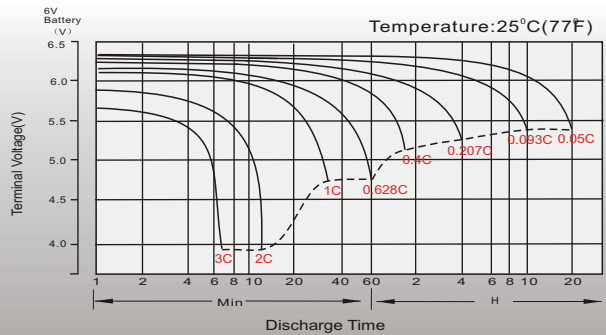

## Float Charging Characteristics

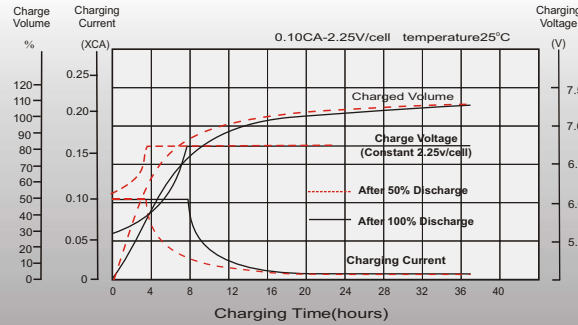

## Temperature Effects in Relation to Battery Capacity

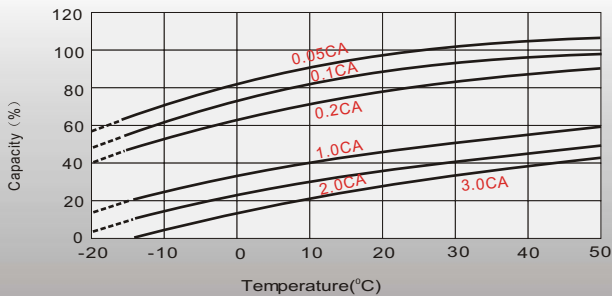

## Effect of Temperature on Long Term Float Life

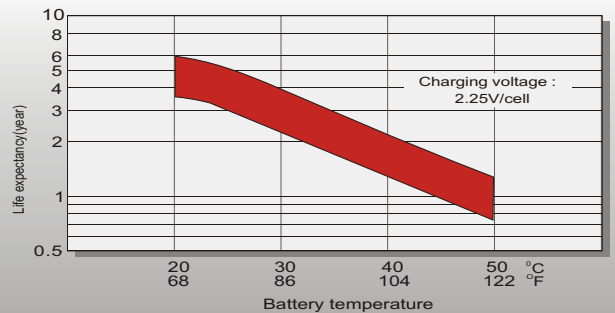

## Cycle Life in Relation to Depth of Discharge

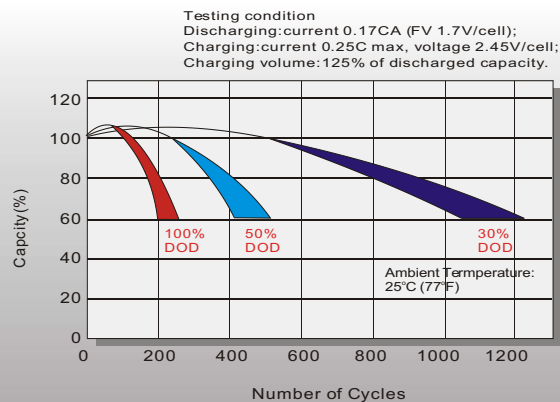

## Self Discharge Characteristics

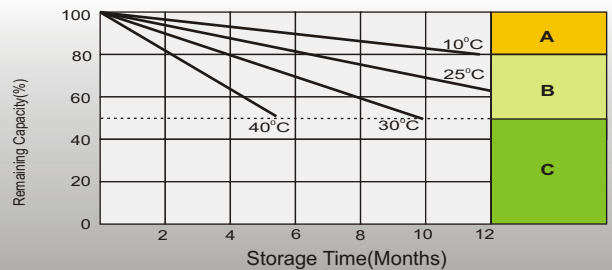

**A** No supplementary charge required  
(Carry out supplementary charge before use if 100% capacity is required.)

Supplementary charge required before use. Optional charging way as below:  
1. Charged for above 3 days at limited current 0.25CA and constant voltage 2.25V/cell.  
2. Charged for above 20 hours at limited current 0.25CA and constant voltage 2.45V/cell.  
3. Charged for 8-10 hours at limited current 0.05CA.

**C** Supplementary charge may often fail to recover the capacity.  
The battery should never be left standing till this is reached.

## Sales Office

### China sales office:

Add: 5th Floor, Xinbaohui Bldg., Nanhai Blvd.,  
Nanshan, Shenzhen, China. 518052  
Tel: +86-755-86036060 (100 lines)  
Fax: +86-755-26067269  
E-mail: [export@leoch.com](mailto:export@leoch.com)  
Http://www.leoch.com

### North America sales office:

Add: 19751 Descartes, Unit A,  
Foothill Ranch, CA 92610, USA  
Tel: 949-588-5853  
Fax: 949-588-5966  
E-mail: [sales@leoch.us](mailto:sales@leoch.us)  
Http://www.leoch.us

### Europe sales office:

Add: 9B Wheatstone Park, Waterwells  
Business Park, Gloucester, GL2 2AQ. UK.  
Tel: +44(0) 1452 729428  
Fax: +44 (0)1452-690125  
E-mail: [Sales.Europe@leoch.com](mailto:Sales.Europe@leoch.com)